



REPUBLIKA E SHQIPERISE
BASHKIA PATOS

DREJTORIA E HARTIMIT TE PROJEKTEVE, MONITORIMIT TE
INVESTIMEVE DHE TE SHERBIMEVE

OBJEKTI:

**RIKUALIFIKIMI URBAN, BLOKU
LAGJIA "NAFTETARI", PRANE
SHKOLLES "MUHAMET SHEHU"**

Emertimi i Fletes:

PROFILAT TERTHORE

RIKUALIFIKIMI DHE SISTEMIMI I BLOKUT TE LAGJES "NAFTETARI"

Grupi i Projektimit:

Ark. Emiljano Gjoni

Ing. Silvana Mici

Ing. Ueda Isufaj

DREJTORIA E HARTIMIT TE
PROJEKTEVE, MONITORIMIT TE
INVESTIMEVE DHE TE SHERBIMEVE

Ing. Arben Manoku

SHKALLA

Fleta:
COVER

SHTATOR
2022



REPUBLIKA E SHQIPERISE
BASHKIA PATOS

DREJTORIA E HARTIMIT TE PROJEKTEVE, MONITORIMIT TE
INVESTIMEVE DHE TE SHERBIMEVE

OBJEKTI:

**RIKUALIFIKIMI URBAN, BLOKU
LAGJIA "NAFTETARI", PRANE
SHKOLLES "MUHAMET SHEHU"**

Emertimi i Fletes:
PROFILAT THERTHORE
Aksi 1

Grupi i Projektimit:

Ark. Emiljano Gjoni

Ing. Silvana Mici

Ing. Ueda Isufaj

DREJTORIA E HARTIMIT TE
PROJEKTEVE, MONITORIMIT TE
INVESTIMEVE DHE TE SHERBIMEVE

Ing. Arben Manoku

SHKALLA

1:100

Fleta:
T-01

SHTATOR
2022

PT
00+000.00

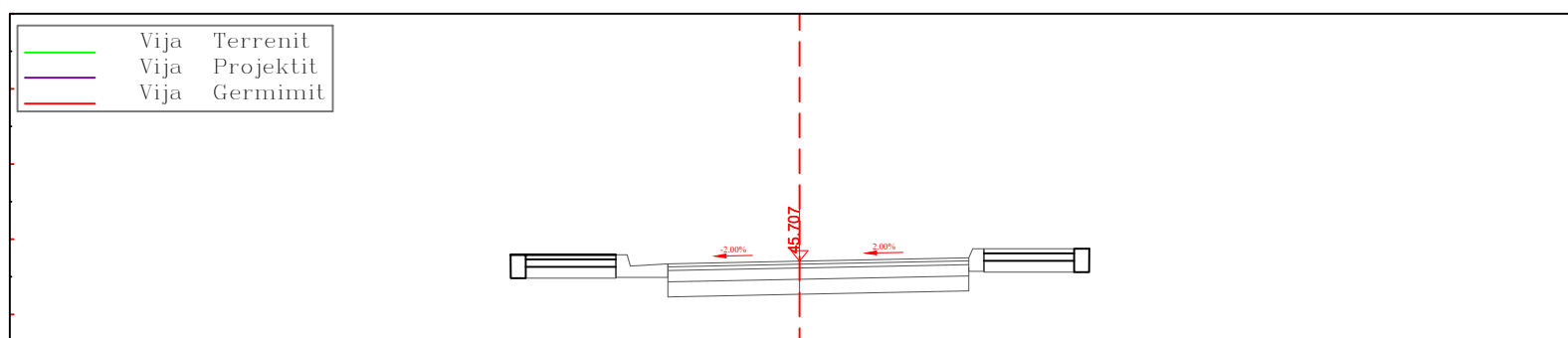

Kuota Terenit			
Dist.Progresive	-10.00	0.00	10.00
Kuota Projektit			
Dist.Progresive		0.00	

PT
00+020.00

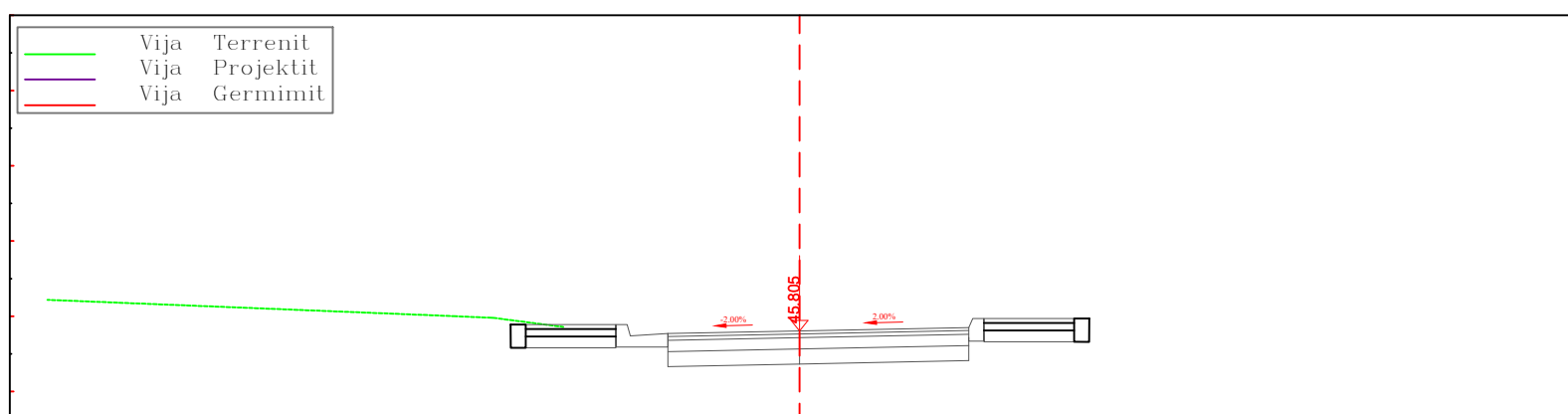

Kuota Terenit	-10.00 46.22	-4.59 46.00	-4.07 45.98	-3.14 45.86	0.00	10.00
Dist.Progresive	-10.00 46.22	-4.59 46.00	-4.07 45.98	-3.14 45.86	0.00	10.00
Kuota Projektit						
Dist.Progresive	-10.00 46.22	-4.59 46.00	-4.07 45.98	-3.14 45.86	0.00	10.00



REPUBLIKA E SHQIPERISE
BASHKIA PATOS

DREJTORIA E HARTIMIT TE PROJEKTEVE, MONITORIMIT TE
INVESTIMEVE DHE TE SHERBIMEVE

OBJEKTI:

**RIKUALIFIKIMI URBAN, BLOKU
LAGJIA "NAFTETARI", PRANE
SHKOLLES "MUHAMET SHEHU"**

Emertimi i Fletes:
PROFILAT THERTHORE
Aksi 1

Grupi i Projektimit:

Ark. Emiljano Gjoni

Ing. Silvana Mici

Ing. Ueda Isufaj

DREJTORIA E HARTIMIT TE
PROJEKTEVE, MONITORIMIT TE
INVESTIMEVE DHE TE SHERBIMEVE

Ing. Arben Manoku

SHKALLA

1:100

Fleta:
T-02

SHTATOR
2022

PT
00+040.00

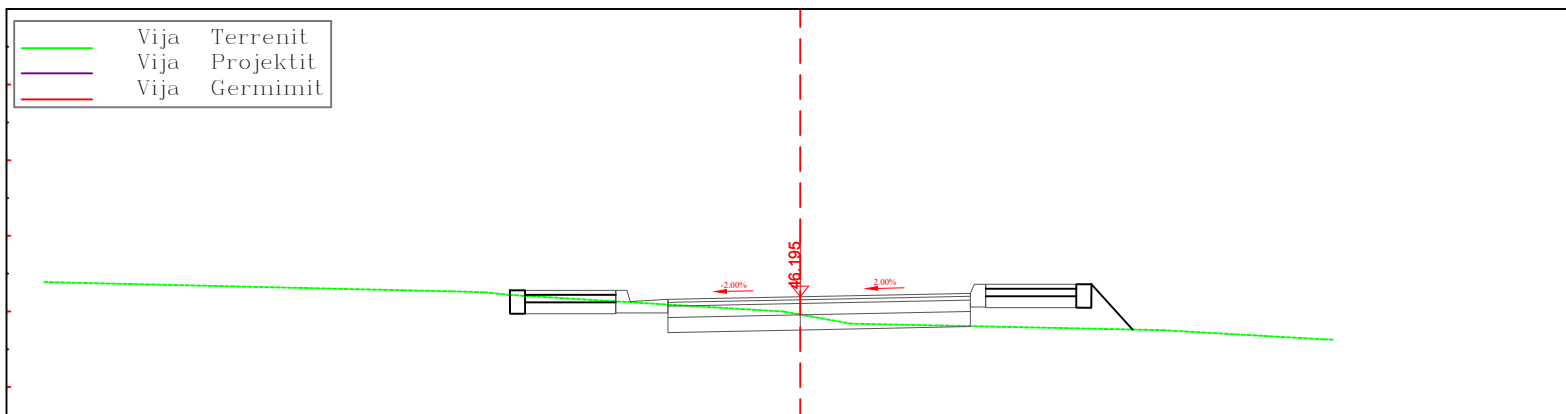

Kuota Terenit	-10.00	46.39	-5.24	46.28	-4.62	46.27	-4.17	46.25	-3.85	46.22	-0.21	46.00	0.00	45.96	0.67	45.84	4.80	45.75	9.87	45.63	10.00
Dist.Progressive	-10.00	46.39	-5.24	46.28	-4.62	46.27	-4.17	46.25	-3.85	46.22	-0.21	46.00	0.00	45.96	0.67	45.84	4.80	45.75	9.87	45.63	10.00
Kuota Projektit	-10.00	46.39	-5.24	46.28	-4.62	46.27	-4.17	46.25	-3.85	46.22	-0.21	46.00	0.00	45.96	0.67	45.84	4.80	45.75	9.87	45.63	10.00
Dist.Progressive	-10.00	46.39	-5.24	46.28	-4.62	46.27	-4.17	46.25	-3.85	46.22	-0.21	46.00	0.00	45.96	0.67	45.84	4.80	45.75	9.87	45.63	10.00

PT
00+060.00

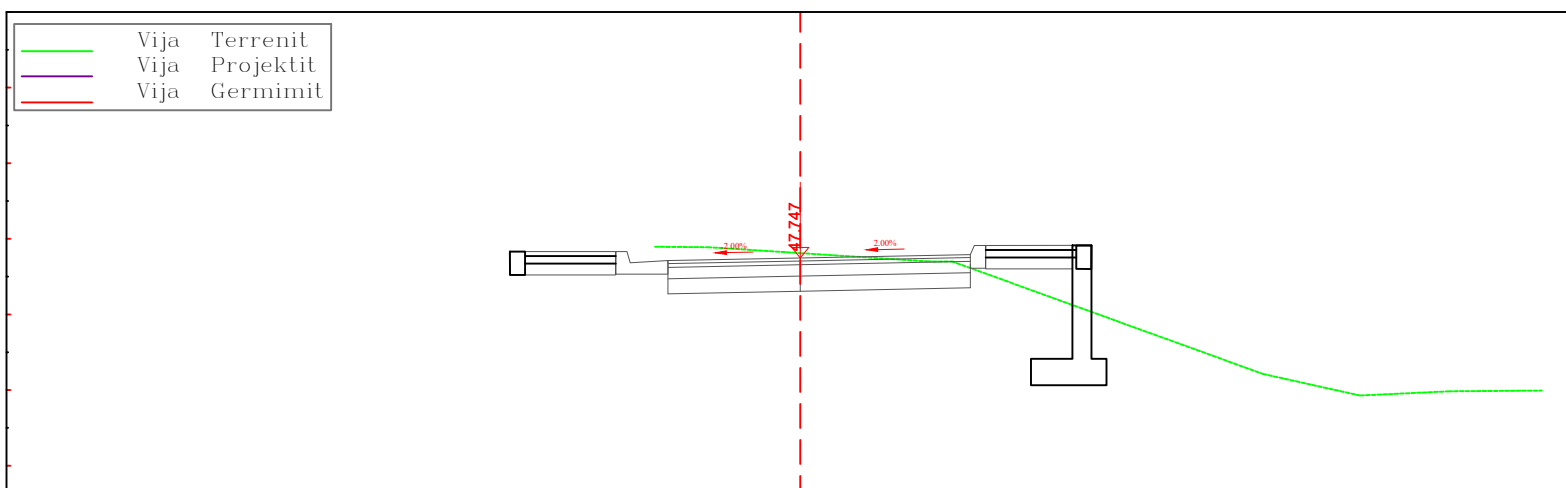

Kuota Terenit	-10.00	-1.92	47.89	-1.20	47.89	0.00	47.81	1.70	47.70	2.01	47.70	6.12	46.21	7.40	45.93	8.59	45.98	9.81	45.99	10.00
Dist.Progressive	-10.00	-1.92	47.89	-1.20	47.89	0.00	47.81	1.70	47.70	2.01	47.70	6.12	46.21	7.40	45.93	8.59	45.98	9.81	45.99	10.00
Kuota Projektit	-10.00	-1.92	47.89	-1.20	47.89	0.00	47.81	1.70	47.70	2.01	47.70	6.12	46.21	7.40	45.93	8.59	45.98	9.81	45.99	10.00
Dist.Progressive	-10.00	-1.92	47.89	-1.20	47.89	0.00	47.81	1.70	47.70	2.01	47.70	6.12	46.21	7.40	45.93	8.59	45.98	9.81	45.99	10.00



REPUBLIKA E SHQIPERISE
BASHKIA PATOS

DREJTORIA E HARTIMIT TE PROJEKTEVE, MONITORIMIT TE
INVESTIMEVE DHE TE SHERBIMEVE

OBJEKTI:

**RIKUALIFIKIMI URBAN, BLOKU
LAGJIA "NAFTETARI", PRANE
SHKOLLES "MUHAMET SHEHU"**

Emertimi i Fletes:
PROFILAT THERTHORE
Aksi 1

Grupi i Projektimit:

Ark. Emiljano Gjoni

Ing. Silvana Mici

Ing. Ueda Isufaj

DREJTORIA E HARTIMIT TE
PROJEKTEVE, MONITORIMIT TE
INVESTIMEVE DHE TE SHERBIMEVE

Ing. Arben Manoku

SHKALLA

1:100

Fleta:
T-03

SHTATOR
2022

PT
00+080.00

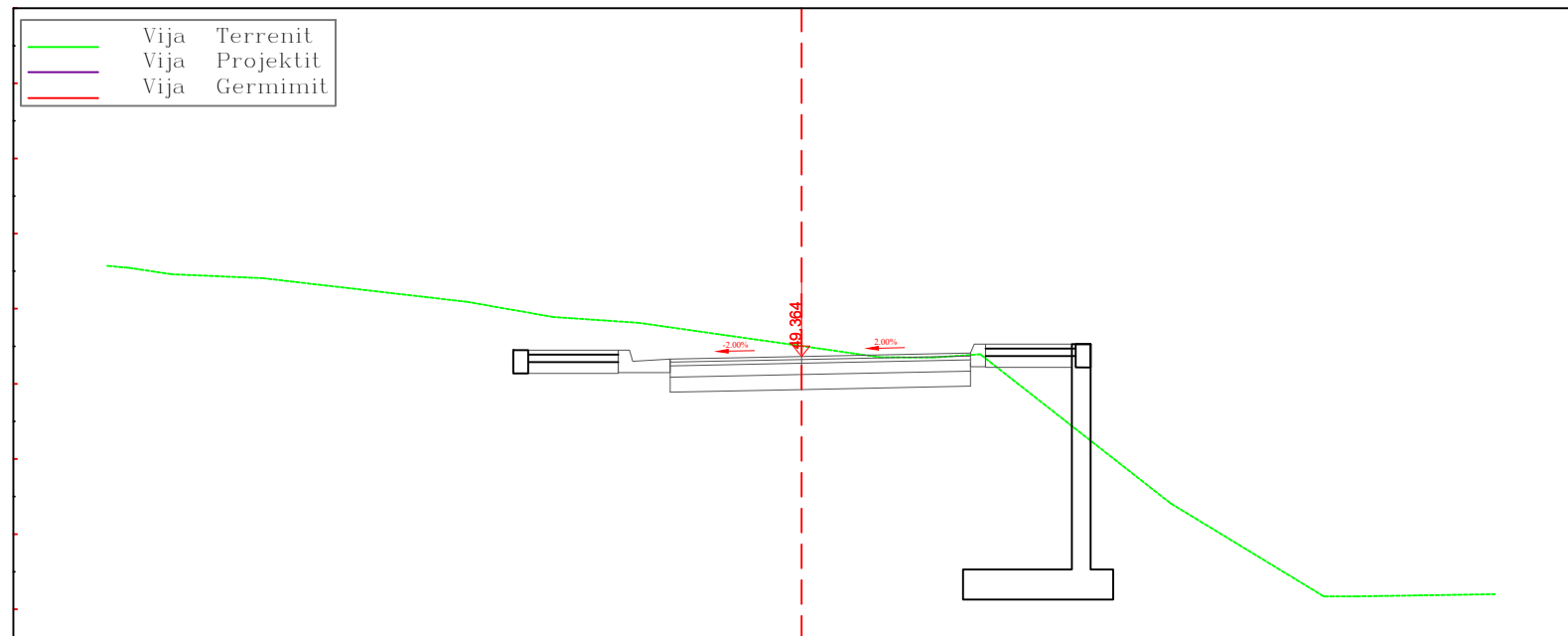

Kuota Terenit	-10.00	-9.25	-8.96	-8.40	-7.18	-4.45	-3.31	-2.18	0.00	1.06	1.75	2.38	4.92	6.96	7.41	9.24	10.00
Dist.Progressive		-9.25	-8.96	-8.40	-7.18	-4.45	-3.31	-2.18	0.00	1.06	1.75	2.38	4.92	6.96	7.41	9.24	10.00
Kuota Projektit		-9.25	-8.96	-8.40	-7.18	-4.45	-3.31	-2.18	0.00	1.06	1.75	2.38	4.92	6.96	7.41	9.24	10.00
Dist.Progressive		-9.25	-8.96	-8.40	-7.18	-4.45	-3.31	-2.18	0.00	1.06	1.75	2.38	4.92	6.96	7.41	9.24	10.00

PT
00+100.00

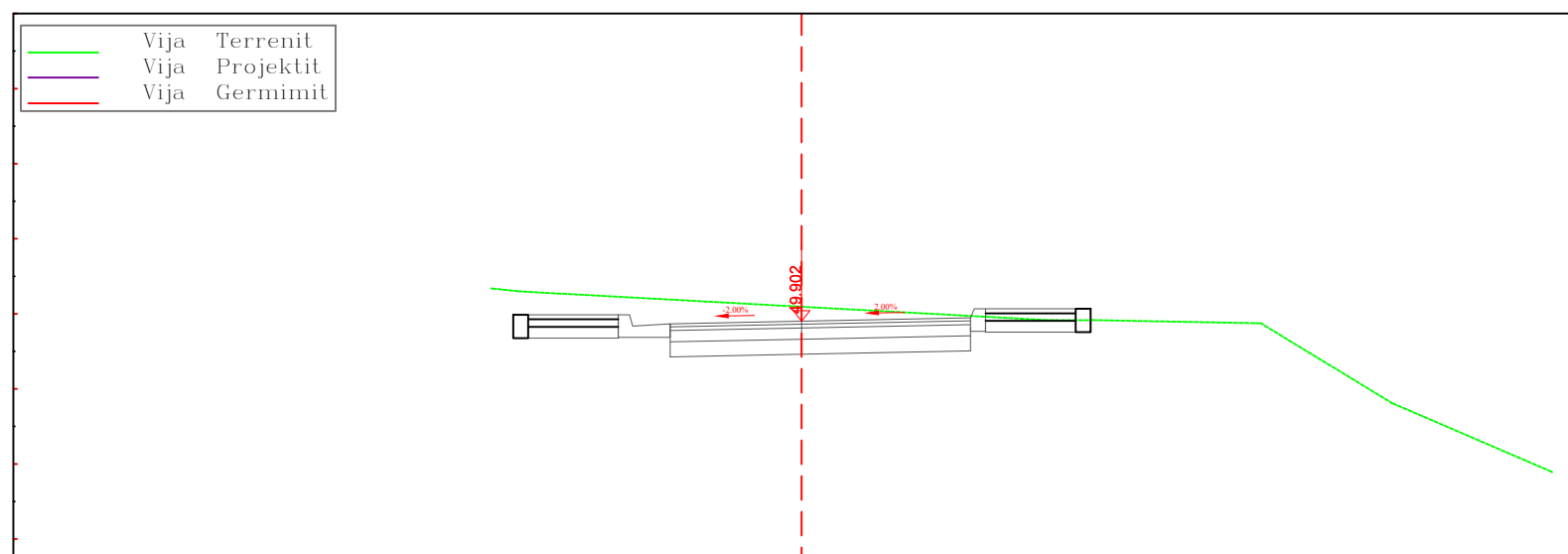

Kuota Terenit	-10.00	-4.13	-3.77	0.00	3.25	3.64	3.87	6.12	7.87	10.00
Dist.Progressive		-4.13	-3.77	0.00	3.25	3.64	3.87	6.12	7.87	10.00
Kuota Projektit		-4.13	-3.77	0.00	3.25	3.64	3.87	6.12	7.87	10.00
Dist.Progressive		-4.13	-3.77	0.00	3.25	3.64	3.87	6.12	7.87	10.00



REPUBLIKA E SHQIPERISE
BASHKIA PATOS

DREJTORIA E HARTIMIT TE PROJEKTEVE, MONITORIMIT TE
INVESTIMEVE DHE TE SHERBIMEVE

OBJEKTI:

**RIKUALIFIKIMI URBAN, BLOKU
LAGJIA "NAFTETARI", PRANE
SHKOLLES "MUHAMET SHEHU"**

Emertimi i Fletes:
PROFILAT THERTHORE
Aksi 1

Grupi i Projektimit:

Ark. Emiljano Gjoni

Ing. Silvana Mici

Ing. Ueda Isufaj

DREJTORIA E HARTIMIT TE
PROJEKTEVE, MONITORIMIT TE
INVESTIMEVE DHE TE SHERBIMEVE

Ing. Arben Manoku

SHKALLA

1:100

Fleta:
T-06

SHTATOR
2022

PT
00+200.00

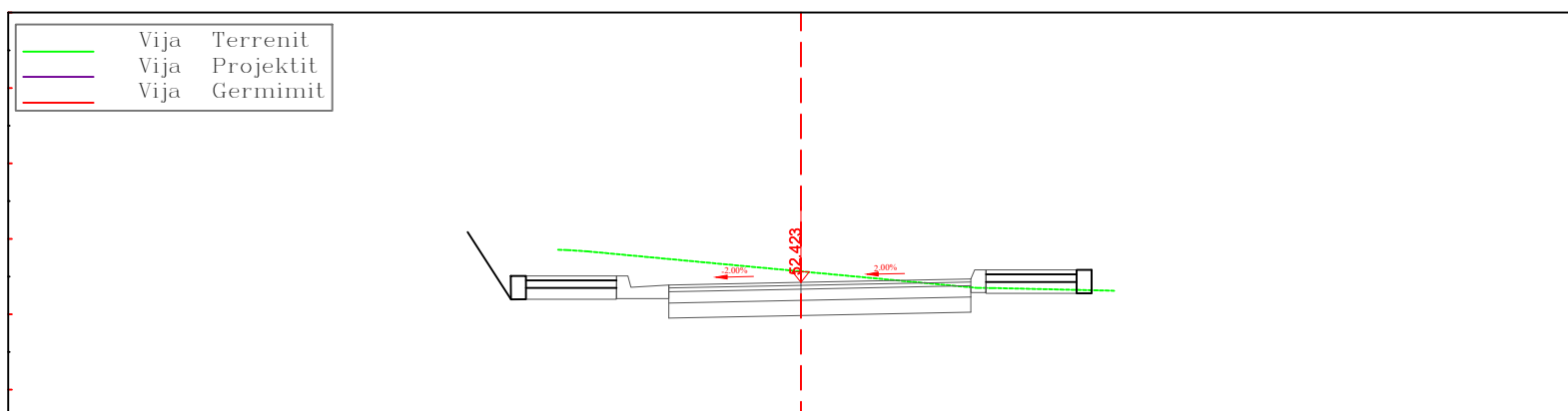

Kuota Terenit								
Dist.Progressive	-10.00							10.00
Kuota Projektit								
Dist.Progressive								

PT
00+204.79

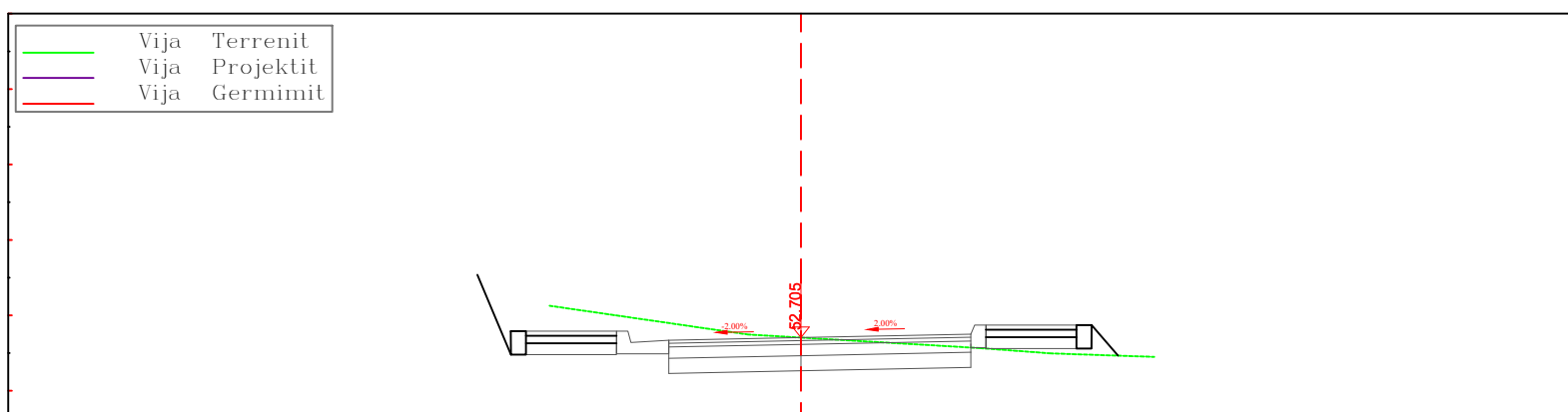

Kuota Terenit								
Dist.Progressive	-10.00							10.00
Kuota Projektit								
Dist.Progressive								



REPUBLIKA E SHQIPERISE
BASHKIA PATOS

DREJTORIA E HARTIMIT TE PROJEKTEVE, MONITORIMIT TE
INVESTIMEVE DHE TE SHERBIMEVE

OBJEKTI:

**RIKUALIFIKIMI URBAN, BLOKU
LAGJIA "NAFTETARI", PRANE
SHKOLLES "MUHAMET SHEHU"**

Emertimi i Fletes:
PROFILAT THERTHORE
Aksi 2

Grupi i Projektimit:

Ark. Emiljano Gjoni

Ing. Silvana Mici

Ing. Ueda Isufaj

DREJTORIA E HARTIMIT TE
PROJEKTEVE, MONITORIMIT TE
INVESTIMEVE DHE TE SHERBIMEVE

Ing. Arben Manoku

SHKALLA

1:100

Fleta:
T-08

SHTATOR
2022

PT
00+020.00

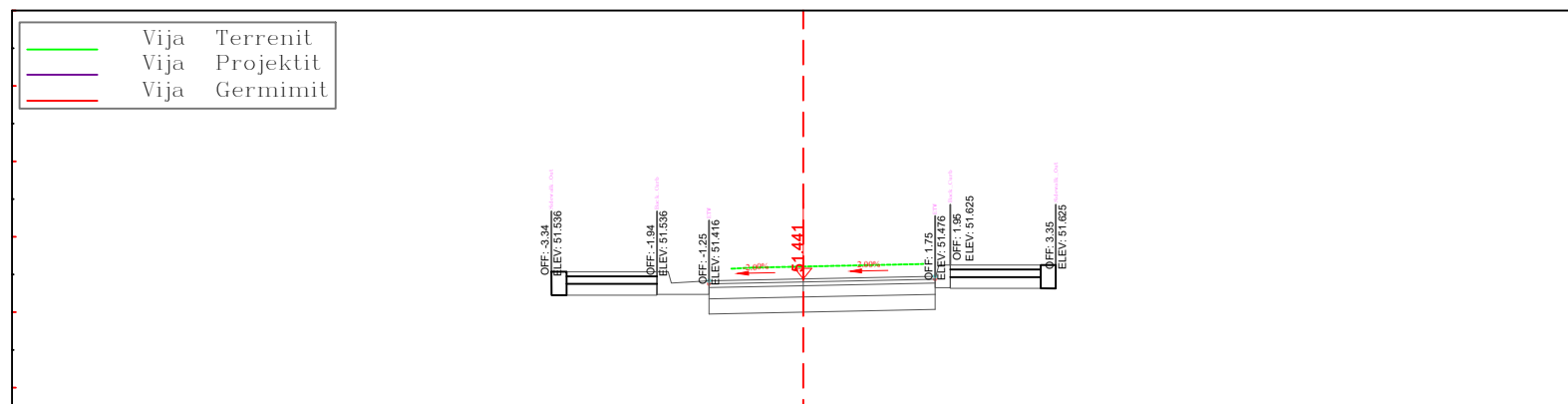

Kuota Terenit				
Kuota Projektit				
Kuota Projektit				
Dist.Progressive		-0.95	-0.67	0.00
		51.58	51.59	51.61
		51.58	51.59	51.61
		51.64	51.64	51.64
		1.59	51.64	51.64

PT
00+027.28

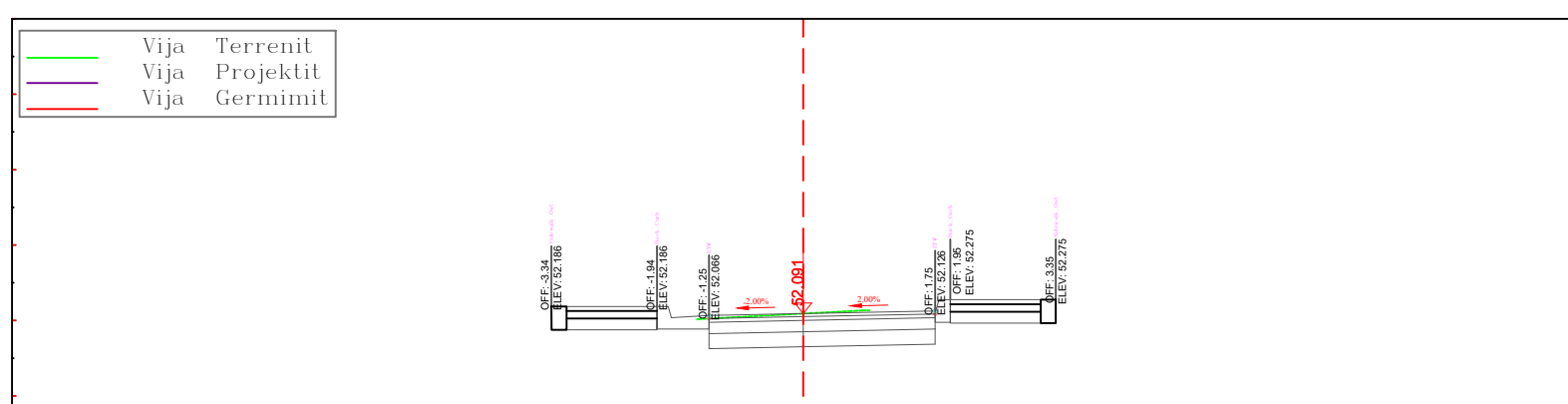

Kuota Terenit				
Kuota Projektit				
Kuota Projektit				
Dist.Progressive		-1.41	0.00	0.88
		52.02	52.09	52.13
		52.02	52.09	52.13
		52.13	52.13	52.13
		52.02	52.13	52.13



REPUBLIKA E SHQIPERISE
BASHKIA PATOS

DREJTORIA E HARTIMIT TE PROJEKTEVE, MONITORIMIT TE
INVESTIMEVE DHE TE SHERBIMEVE

OBJEKTI:

**RIKUALIFIKIMI URBAN, BLOKU
LAGJIA "NAFTETARI", PRANE
SHKOLLES "MUHAMET SHEHU"**

Emertimi i Fletes:
PROFILAT THERTHORE
Aksi 3

Grupi i Projektimit:

Ark. Emiljano Gjoni

Ing. Silvana Mici

Ing. Ueda Isufaj

DREJTORIA E HARTIMIT TE
PROJEKTEVE, MONITORIMIT TE
INVESTIMEVE DHE TE SHERBIMEVE

Ing. Arben Manoku

SHKALLA

1:100

Fleta:
T-09

SHTATOR
2022

PT
00+000.00

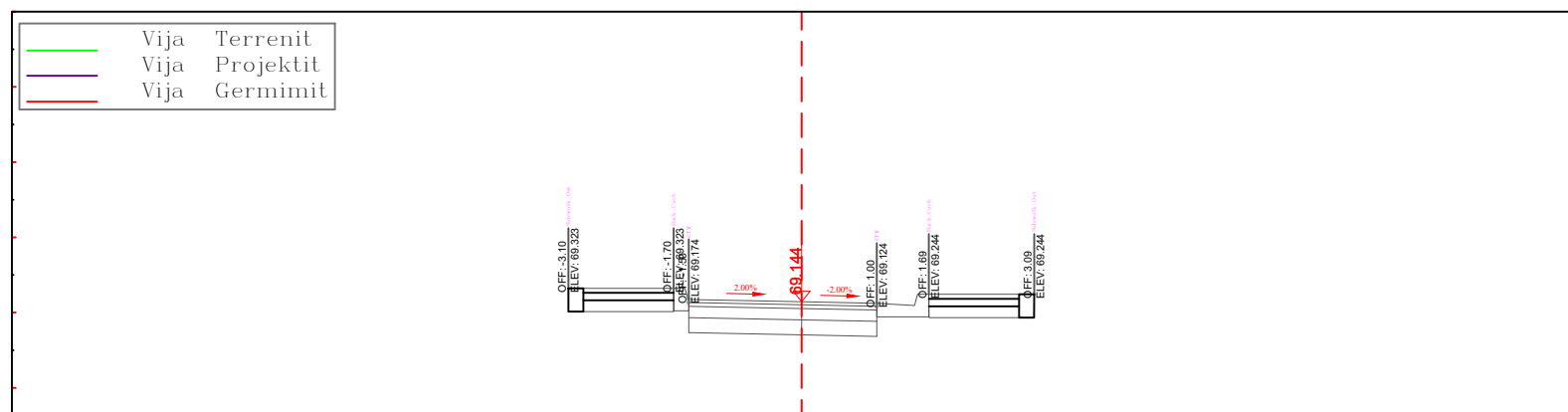

Kuota Terenit			
Dist.Progressive	-10.00	0.00	10.00
Kuota Projektit			
Dist.Progressive		0.00	

PT
00+010.00

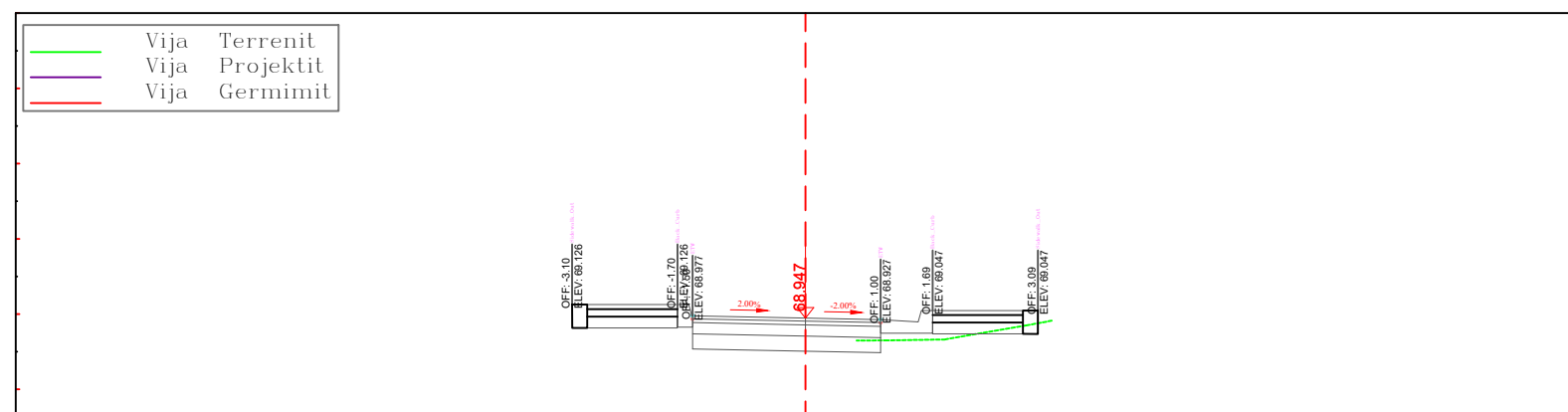

Kuota Terenit								
Dist.Progressive	-10.00	0.00	0.68	1.08	1.85	2.94	3.28	10.00
Kuota Projektit			68.65	68.65	68.66	68.85	68.91	
Dist.Progressive		0.00	0.68	1.08	1.85	2.94	3.28	



REPUBLIKA E SHQIPERISE
BASHKIA PATOS

DREJTORIA E HARTIMIT TE PROJEKTEVE, MONITORIMIT TE
INVESTIMEVE DHE TE SHERBIMEVE

OBJEKTI:

**RIKUALIFIKIMI URBAN, BLOKU
LAGJIA "NAFTETARI", PRANE
SHKOLLES "MUHAMED SHEHU"**

Emertimi i Fletes:
PROFILAT THERTHORE
Aksi 3

Grupi i Projektimit:

Ark. Emiljano Gjoni

Ing. Silvana Mici

Ing. Ueda Isufaj

DREJTORIA E HARTIMIT TE
PROJEKTEVE, MONITORIMIT TE
INVESTIMEVE DHE TE SHERBIMEVE

Ing. Arben Manoku

SHKALLA

1:100

Fleta:
T-10

SHTATOR
2022

PT
00+020.00

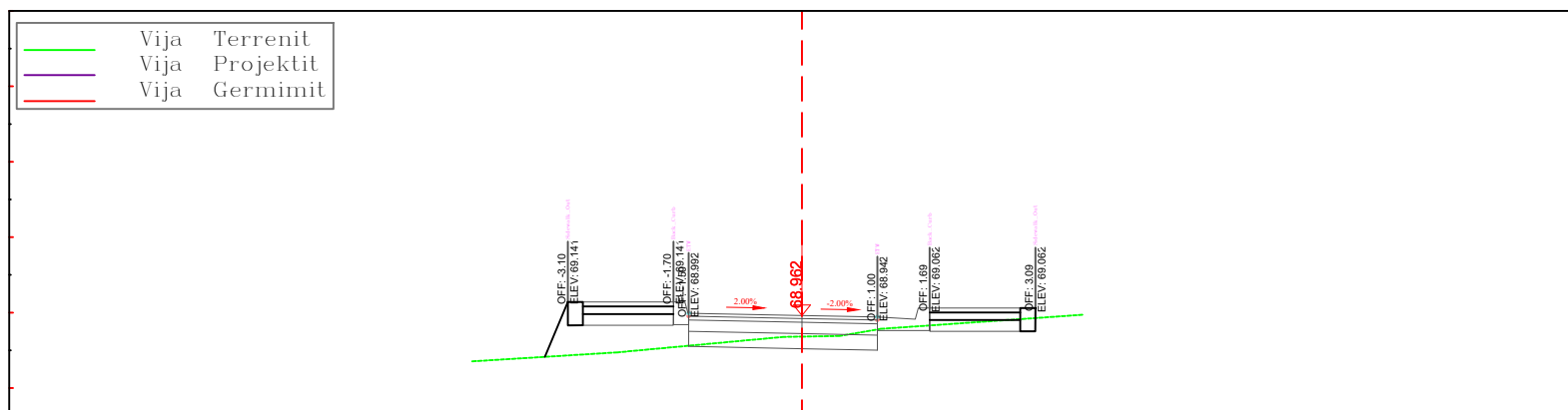

Kuota Terenit											
Dist.Progressive	-10.00								10.00		
Kuota Projektit											
Dist.Progressive		-4.37	68.35	-2.44	68.47	-0.25	68.68	0.49	68.69	3.71	68.97

PT
00+030.00

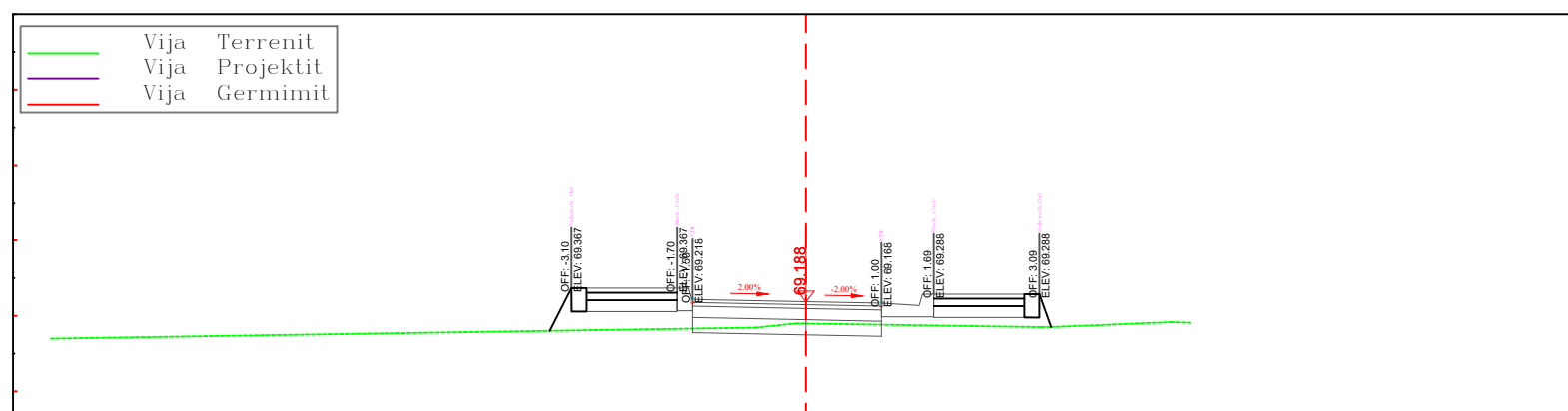

Kuota Terenit												
Dist.Progressive	-10.00	68.70							10.00			
Kuota Projektit												
Dist.Progressive	-10.00	68.70	-0.66	68.84	-0.13	68.90	3.25	68.85	4.85	68.92	5.10	68.91



REPUBLIKA E SHQIPERISE
BASHKIA PATOS

DREJTORIA E HARTIMIT TE PROJEKTEVE, MONITORIMIT TE
INVESTIMEVE DHE TE SHERBIMEVE

OBJEKTI:

**RIKUALIFIKIMI URBAN, BLOKU
LAGJIA "NAFTETARI", PRANE
SHKOLLES "MUHAMET SHEHU"**

Emertimi i Fletes:
PROFILAT THERTHORE
Aksi 3

Grupi i Projektimit:

Ark. Emiljano Gjoni

Ing. Silvana Mici

Ing. Ueda Isufaj

DREJTORIA E HARTIMIT TE
PROJEKTEVE, MONITORIMIT TE
INVESTIMEVE DHE TE SHERBIMEVE

Ing. Arben Manoku

SHKALLA

1:100

Fleta:
T-11

SHTATOR
2022

PT
00+040.00

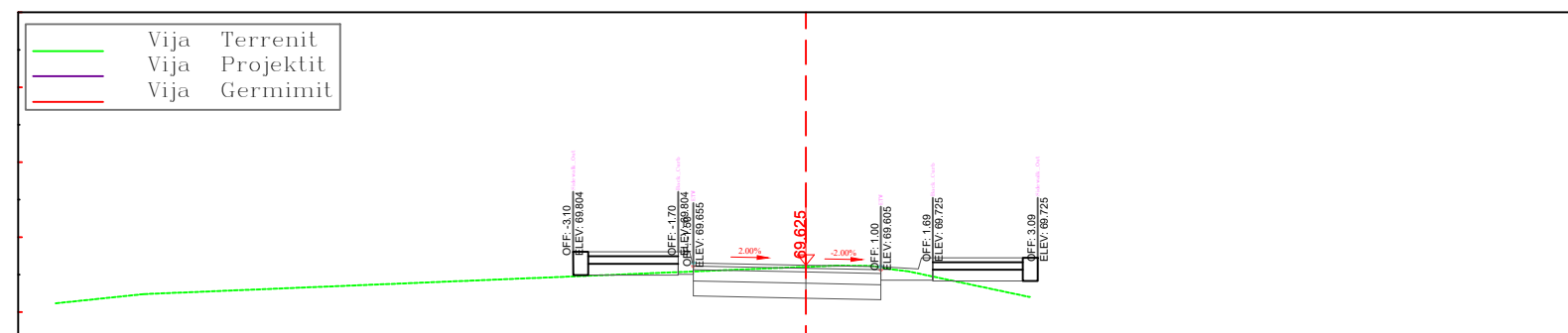

Kuota Terenit	69.12	69.24	69.60	69.62	69.62	69.56	69.54	69.20	
Dist.Progressive	-10.00	-8.83	0.00	0.41	0.88	1.18	1.36	2.99	10.00
Kuota Projektit	69.12	69.24	69.60	69.62	69.62	69.56	69.54	69.20	
Dist.Progressive	-10.00	-8.83	0.00	0.41	0.88	1.18	1.36	2.99	10.00

PT
00+050.00

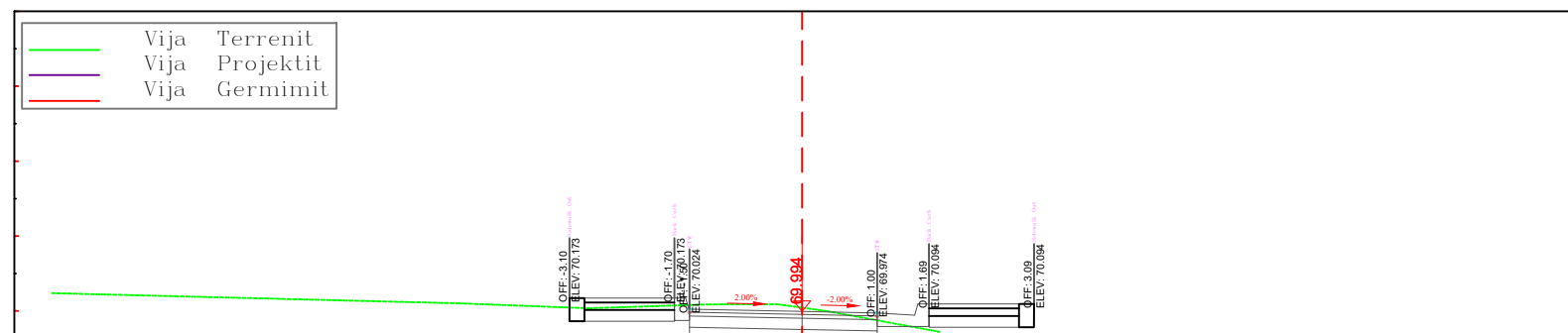

Kuota Terenit	70.24	70.10	70.04	70.09	70.09	70.04	70.00	69.72	
Dist.Progressive	-10.00	-4.57	-2.85	-1.24	-0.33	0.00	0.33	1.83	10.00
Kuota Projektit	70.24	70.10	70.04	70.09	70.09	70.04	70.00	69.72	
Dist.Progressive	-10.00	-4.57	-2.85	-1.24	-0.33	0.00	0.33	1.83	10.00



REPUBLIKA E SHQIPERISE
BASHKIA PATOS

DREJTORIA E HARTIMIT TE PROJEKTEVE, MONITORIMIT TE
INVESTIMEVE DHE TE SHERBIMEVE

OBJEKTI:

RIKUALIFIKIMI URBAN, BLOKU
LAGJIA "NAFTETARI", PRANE
SHKOLLES "MUHAMET SHEHU"

Emertimi i Fletes:
PROFILAT THERTHORE
Aksi 3

Grupi i Projektimit:

Ark. Emiljano Gjoni

Ing. Silvana Mici

Ing. Ueda Isufaj

DREJTORIA E HARTIMIT TE
PROJEKTEVE, MONITORIMIT TE
INVESTIMEVE DHE TE SHERBIMEVE

Ing. Arben Manoku

SHKALLA

1:100

Fleta:
T-12

SHTATOR
2022

PT
00+060.00

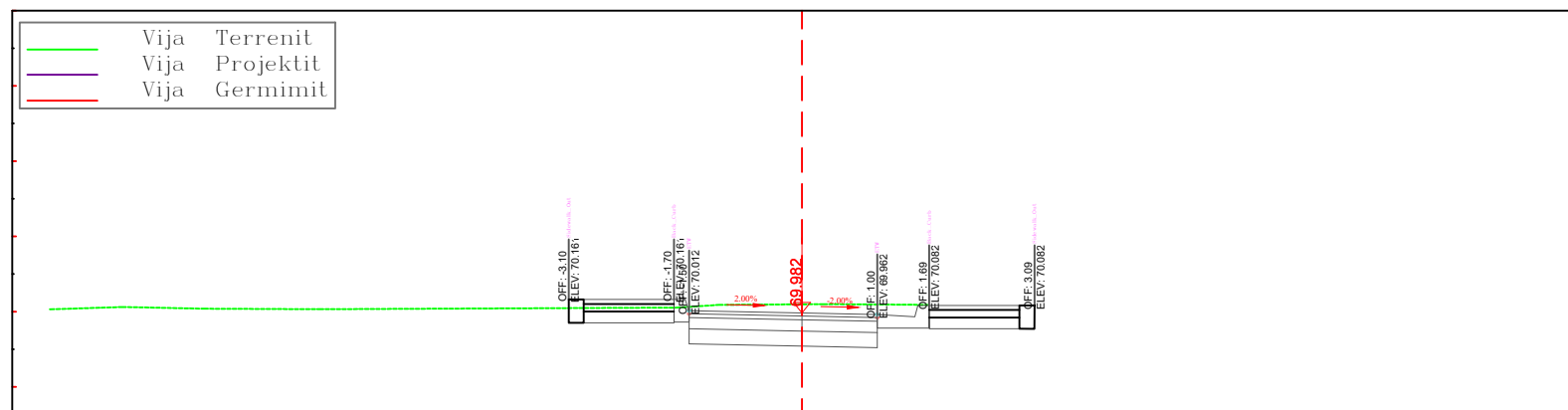

Kuota Terenit	-10.00	70.03	-10.00	70.03						
Dist.Progressive			-9.03	70.06	-9.03	70.06				
Kuota Projektit			-7.95	70.04	-7.95	70.04				
Dist.Progressive			-6.40	70.03	-6.40	70.03				10.00

PT
00+070.00

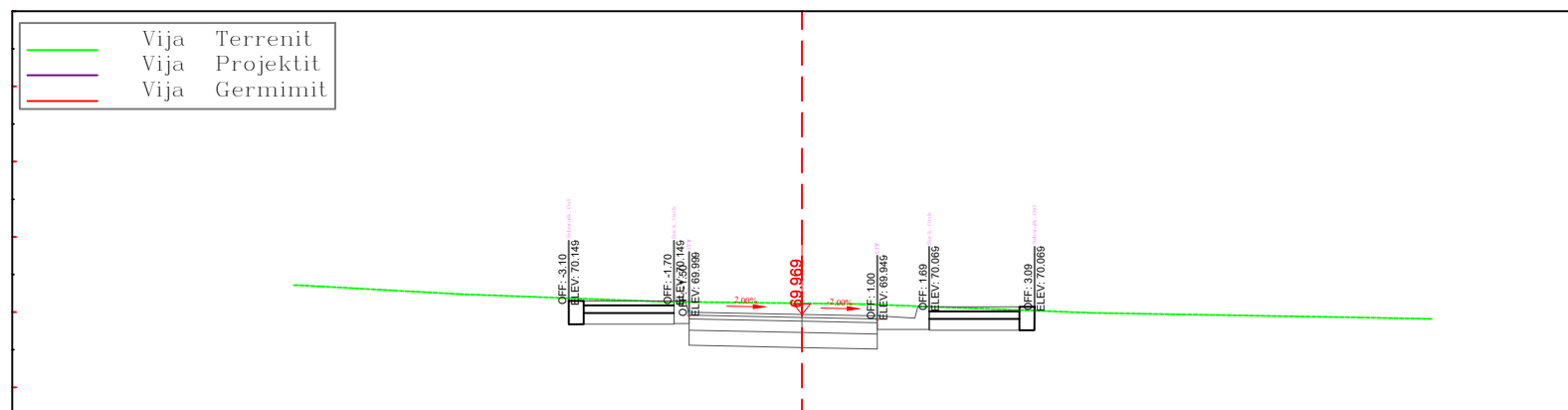

Kuota Terenit			-6.76	70.36	-6.76	70.36				
Dist.Progressive	-10.00		-6.40	70.34	-6.40	70.34				
Kuota Projektit			-4.55	70.24	-4.55	70.24				
Dist.Progressive			-1.88	70.14	-1.88	70.14				10.00



REPUBLIKA E SHQIPERISE
BASHKIA PATOS

DREJTORIA E HARTIMIT TE PROJEKTEVE, MONITORIMIT TE
INVESTIMEVE DHE TE SHERBIMEVE

OBJEKTI:

RIKUALIFIKIMI URBAN, BLOKU
LAGJIA "NAFTETARI", PRANE
SHKOLLES "MUHAMET SHEHU"

Emertimi i Fletes:

PROFILAT THERTHORE

Aksi 3

Grupi i Projektimit:

Ark. Emiljano Gjoni

Ing. Silvana Mici

Ing. Ueda Isufaj

DREJTORIA E HARTIMIT TE
PROJEKTEVE, MONITORIMIT TE
INVESTIMEVE DHE TE SHERBIMEVE

Ing. Arben Manoku

SHKALLA

1:100

Fleta:
T-13

SHTATOR
2022

PT
00+076.21

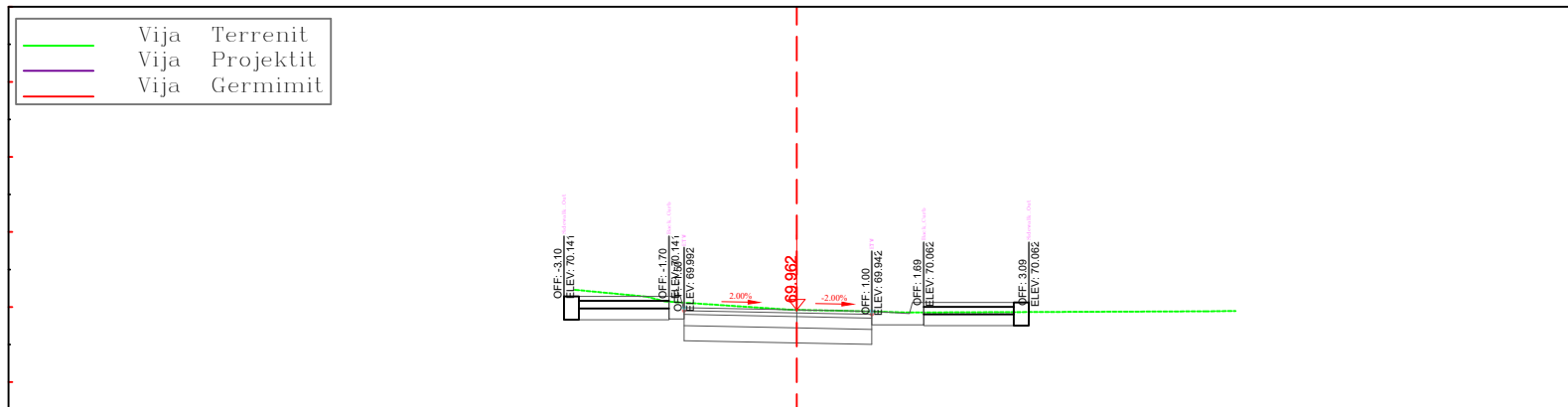

Vija Terrenit
Vija Projektit
Vija Germimit

Kuota Terenit		-2.96	70.23	-2.96	70.23						
Dist.Progressive	-10.00										10.00
Kuota Projektit		-2.00	70.14	-2.00	70.14	-1.76	70.08	-1.76	70.08		
Dist.Progressive		-2.96	70.23	-2.96	70.23	-0.68	69.96	-0.68	69.96	0.57	69.95
										1.50	69.93
										5.47	69.94
										5.85	69.95



REPUBLIKA E SHQIPERISE
BASHKIA PATOS

DREJTORIA E HARTIMIT TE PROJEKTEVE, MONITORIMIT TE
INVESTIMEVE DHE TE SHERBIMEVE

OBJEKTI:

RIKUALIFIKIMI URBAN, BLOKU
LAGJIA "NAFTETARI", PRANE
SHKOLLES "MUHAMET SHEHU"

Emertimi i Fletes:
PROFILAT THERTHORE
Aksi 4

Grupi i Projektimit:

Ark. Emiljano Gjoni

Ing. Silvana Mici

Ing. Ueda Isufaj

DREJTORIA E HARTIMIT TE
PROJEKTEVE, MONITORIMIT TE
INVESTIMEVE DHE TE SHERBIMEVE

Ing. Arben Manoku

SHKALLA

1:100

Fleta:
T-14

SHTATOR
2022

PT
00+000.00

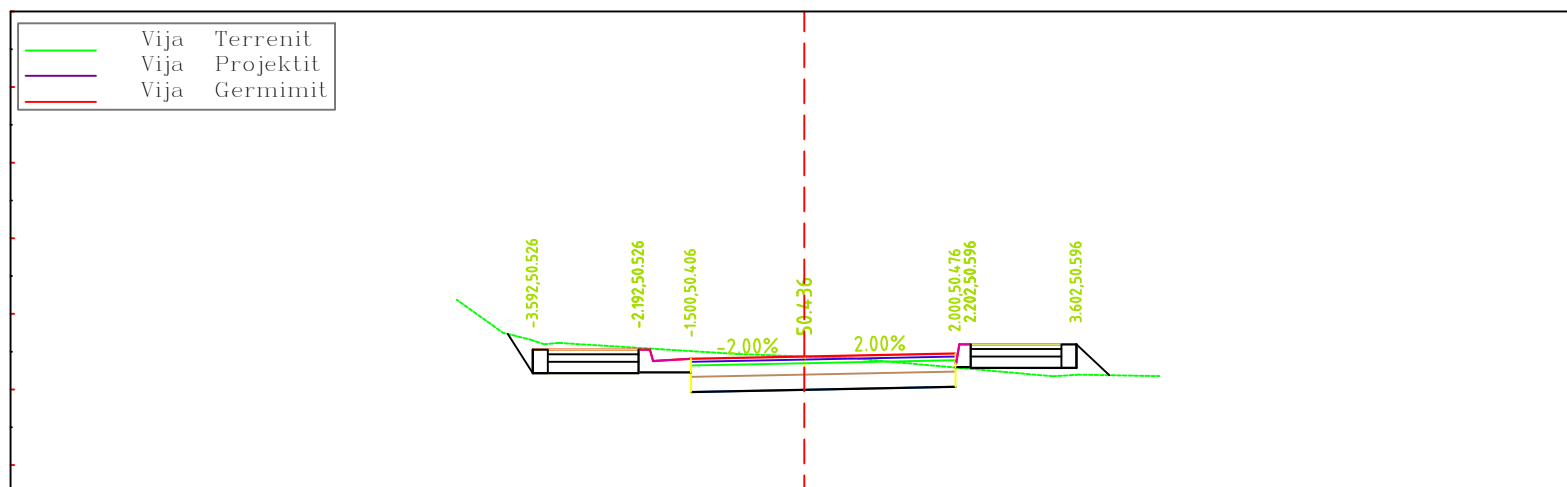

Kuota Terenit				-4.60	51.19				
Dist.Progressive	-10.00					-3.99	50.75	-3.61	50.66
Kuota Projektit				-4.60	51.19	-3.44	50.60	-3.25	50.62
Dist.Progressive						-0.87	50.47	0.00	50.44
						0.63	50.41	0.63	50.41
						3.29	50.17	3.63	50.20
						4.70	50.18	4.70	50.18
						10.00			

PT
00+020.00

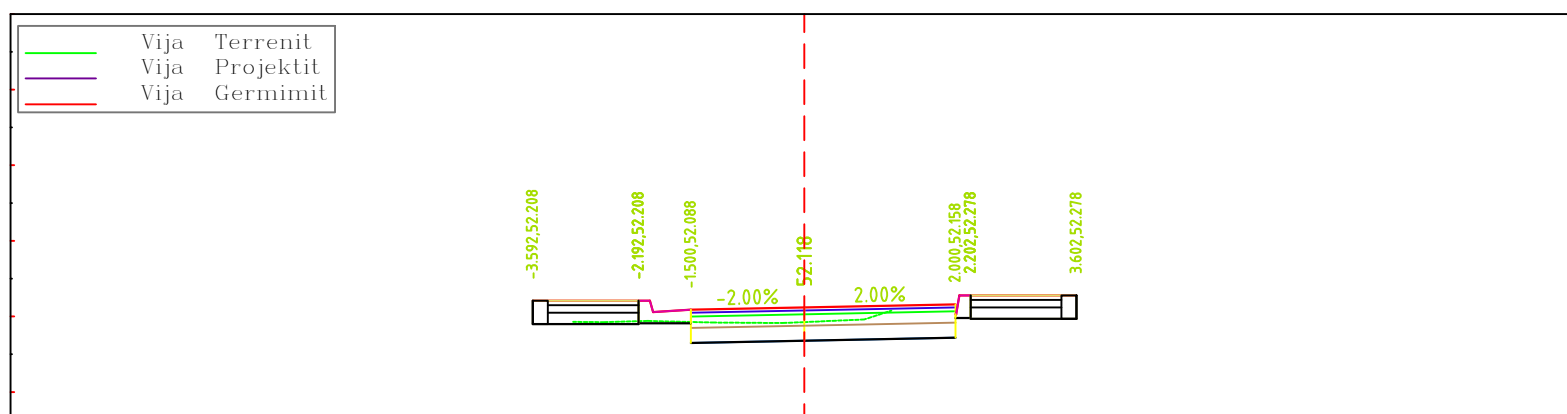

Kuota Terenit									
Dist.Progressive	-10.00					-3.06	51.93	-2.65	51.92
Kuota Projektit						-2.07	51.94	-1.19	51.92
Dist.Progressive						-0.29	51.91	0.00	51.93
						0.79	51.96	1.15	52.08
						10.00			



REPUBLIKA E SHQIPERISE
BASHKIA PATOS

DREJTORIA E HARTIMIT TE PROJEKTEVE, MONITORIMIT TE
INVESTIMEVE DHE TE SHERBIMEVE

OBJEKTI:

RIKUALIFIKIMI URBAN, BLOKU
LAGJIA "NAFTETARI", PRANE
SHKOLLES "MUHAMET SHEHU"

Emertimi i Fletes:
PROFILAT THERTHORE
Aksi 4

Grupi i Projektimit:

Ark. Emiljano Gjoni

Ing. Silvana Mici

Ing. Ueda Isufaj

DREJTORIA E HARTIMIT TE
PROJEKTEVE, MONITORIMIT TE
INVESTIMEVE DHE TE SHERBIMEVE

Ing. Arben Manoku

SHKALLA

1:100

Fleta:
T-16

SHTATOR
2022

PT
00+080.00

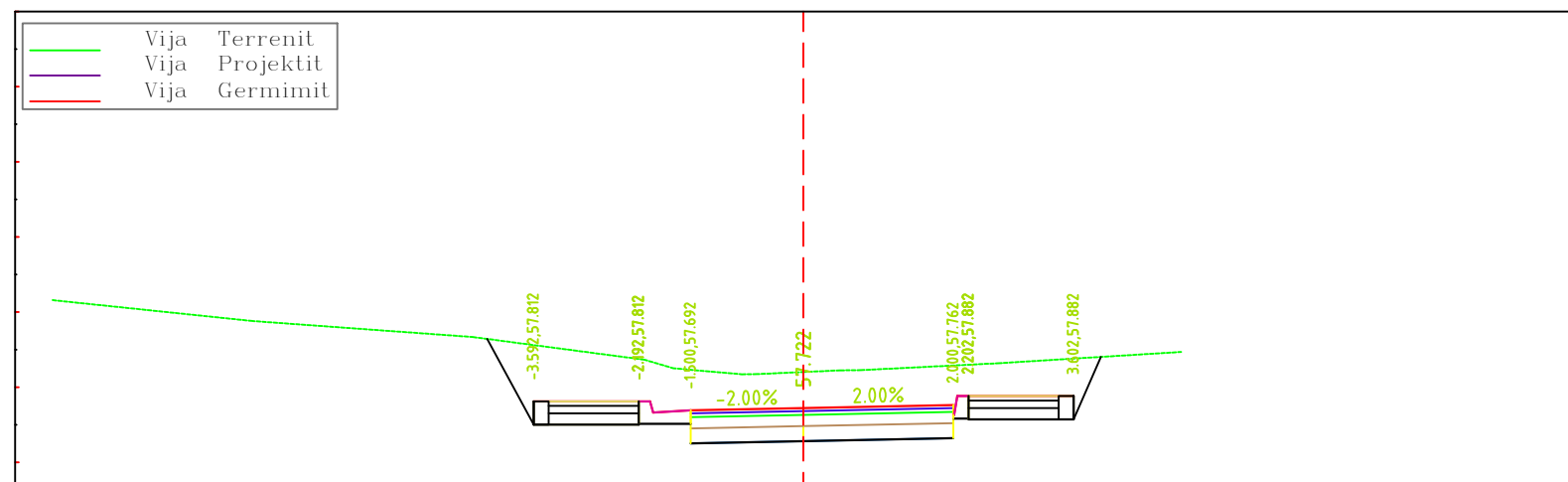

Kuota Terenit	-10.00	59.16	-10.00	59.16
Dist.Progressive	-7.34	58.88	-7.34	58.88
Kuota Projektit	-4.40	58.67	-4.40	58.67
Dist.Progressive	-2.12	58.37	-2.12	58.37
	-1.73	58.25	-1.73	58.25
	-0.82	58.17	-0.82	58.17
	-0.62	58.17	-0.62	58.17
	0.00	58.20	0.00	58.20
	0.49	58.22	0.49	58.22
	0.78	58.23	0.78	58.23
	2.60	58.32	2.60	58.32
	5.03	58.47	5.03	58.47
				10.00

PT
00+100.00

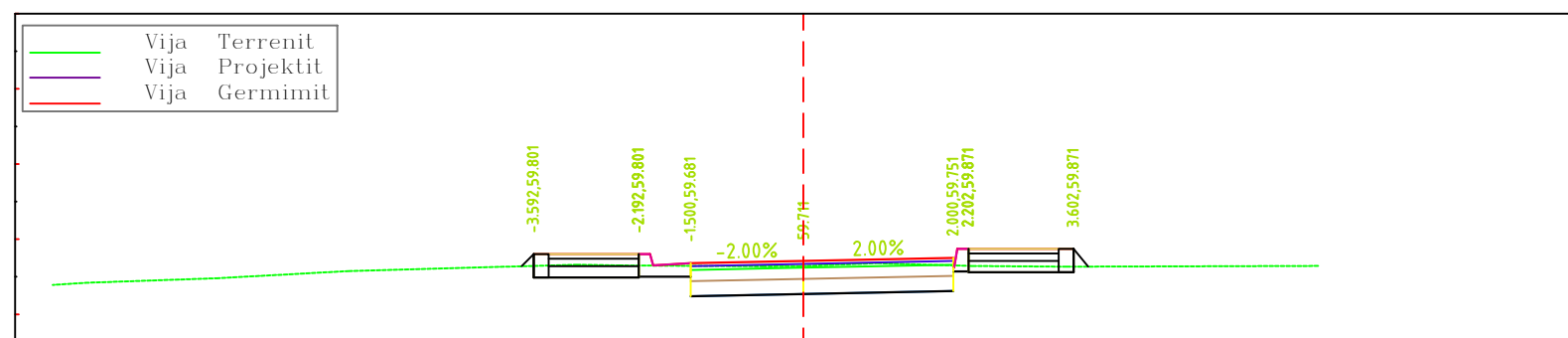

Kuota Terenit	-10.00	59.39	-10.00	59.39
Dist.Progressive	-9.55	59.42	-9.55	59.42
Kuota Projektit	-7.81	59.48	-7.81	59.48
Dist.Progressive	-6.06	59.58	-6.06	59.58
	-3.01	59.66	-3.01	59.66
	-2.45	59.65	-2.45	59.65
	-0.53	59.64	-0.53	59.64
	-0.00	59.64	-0.00	59.64
	0.98	59.68	0.98	59.68
	2.25	59.64	2.25	59.64
	3.51	59.63	3.51	59.63
	6.86	59.64	6.86	59.64
				10.00



REPUBLIKA E SHQIPERISE
BASHKIA PATOS

DREJTORIA E HARTIMIT TE PROJEKTEVE, MONITORIMIT TE
INVESTIMEVE DHE TE SHERBIMEVE

OBJEKTI:

RIKUALIFIKIMI URBAN, BLOKU
LAGJIA "NAFTETARI", PRANE
SHKOLLES "MUHAMET SHEHU"

Emertimi i Fletes:
PROFILAT THERTHORE
Aksi 4

Grupi i Projektimit:

Ark. Emiljano Gjoni

Ing. Silvana Mici

Ing. Ueda Isufaj

DREJTORIA E HARTIMIT TE
PROJEKTEVE, MONITORIMIT TE
INVESTIMEVE DHE TE SHERBIMEVE

Ing. Arben Manoku

SHKALLA

1:100

Fleta:
T-17

SHTATOR
2022

PT
00+120.00

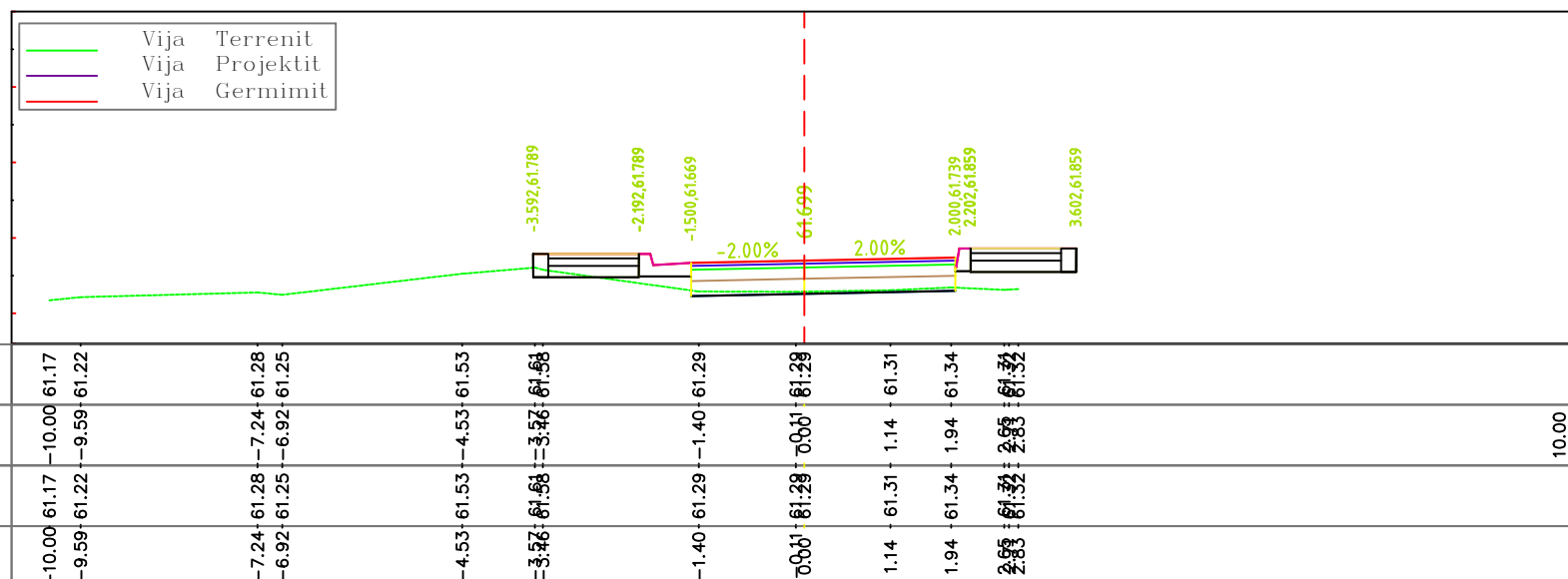

PT
00+140.00

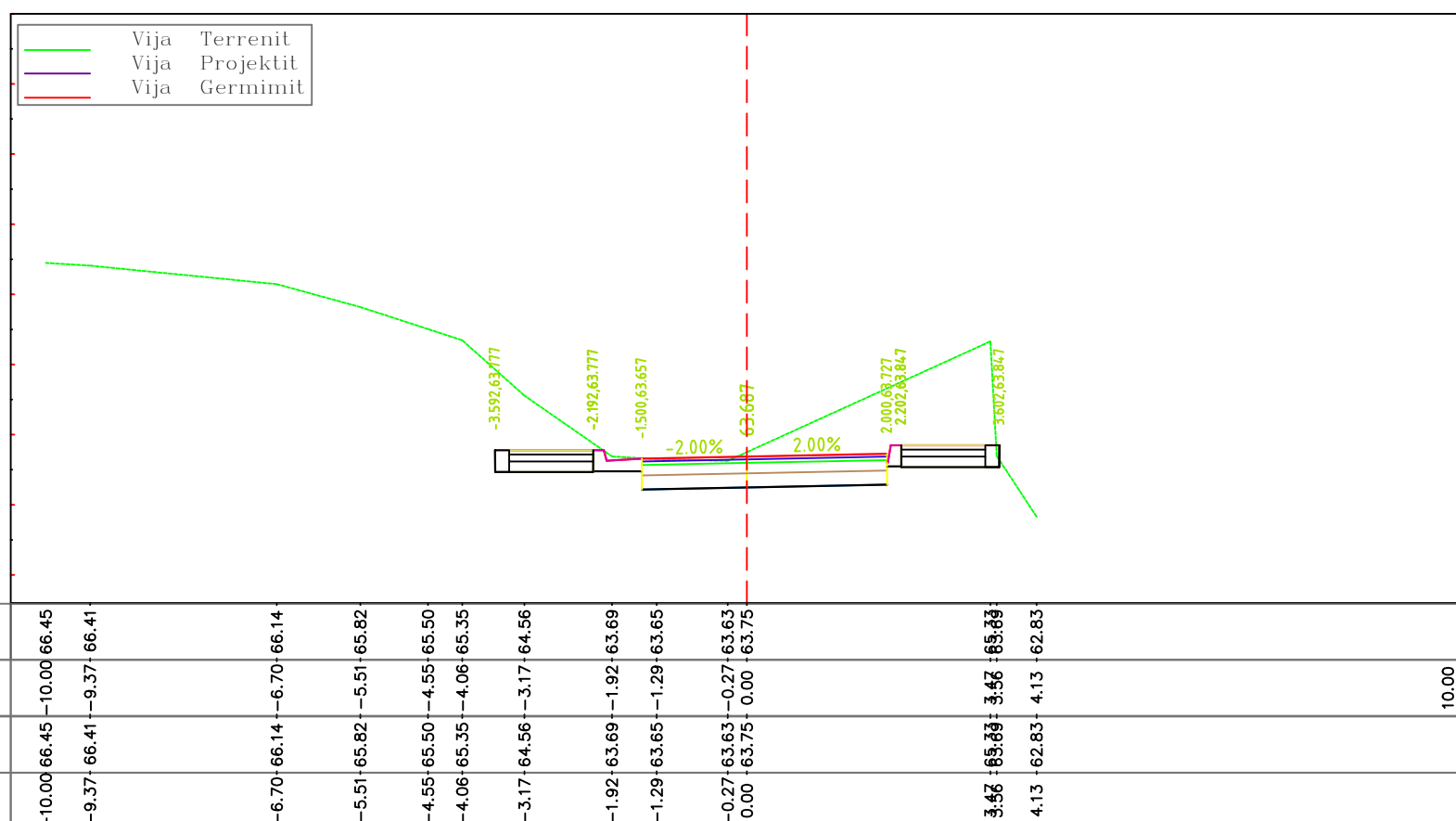



REPUBLIKA E SHQIPERISE
BASHKIA PATOS

DREJTORIA E HARTIMIT TE PROJEKTEVE, MONITORIMIT TE
INVESTIMEVE DHE TE SHERBIMEVE

OBJEKTI:

RIKUALIFIKIMI URBAN, BLOKU
LAGJIA "NAFTETARI", PRANE
SHKOLLES "MUHAMET SHEHU"

Emertimi i Fletes:
PROFILAT THERTHORE
Aksi 5

Grupi i Projektimit:

Ark. Emiljano Gjoni

Ing. Silvana Mici

Ing. Ueda Isufaj

DREJTORIA E HARTIMIT TE
PROJEKTEVE, MONITORIMIT TE
INVESTIMEVE DHE TE SHERBIMEVE

Ing. Arben Manoku

SHKALLA

1:100

Fleta:
T-21

SHTATOR
2022

PT
00+000.00

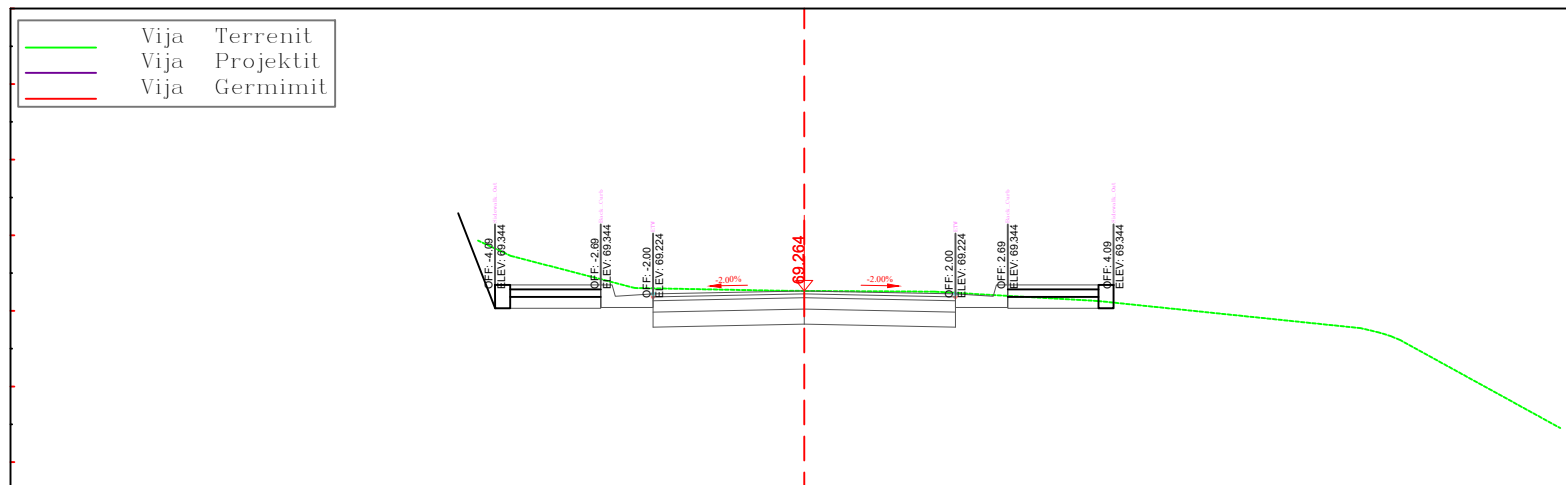

Kuota Terenit	-4.32	-69.93	-69.93	-69.93	-0.26	-69.27	-69.27	-69.27	1.72	-69.25	-69.25	-69.25	3.89	-69.13	-69.13	-69.13	7.36	-68.77	-68.77	-68.77	-10.00	-67.45	-67.45	-67.45
Kuota Projektit	-3.88	-69.73	-69.73	-69.73	-0.00	-69.26	-69.26	-69.26	1.72	-69.25	-69.25	-69.25	3.89	-69.13	-69.13	-69.13	7.59	-68.72	-68.72	-68.72	-10.00	-67.45	-67.45	-67.45
Kuota Projektit	-4.32	-69.93	-69.93	-69.93	-0.26	-69.27	-69.27	-69.27	1.72	-69.25	-69.25	-69.25	3.89	-69.13	-69.13	-69.13	7.36	-68.77	-68.77	-68.77	-10.00	-67.45	-67.45	-67.45
Dist.Progresive	-4.32	-69.93	-69.93	-69.93	-0.26	-69.27	-69.27	-69.26	1.72	-69.25	-69.25	-69.25	3.89	-69.13	-69.13	-69.13	7.36	-68.77	-68.77	-68.67	-10.00	-67.45	-67.45	-67.45

PT
00+010.00

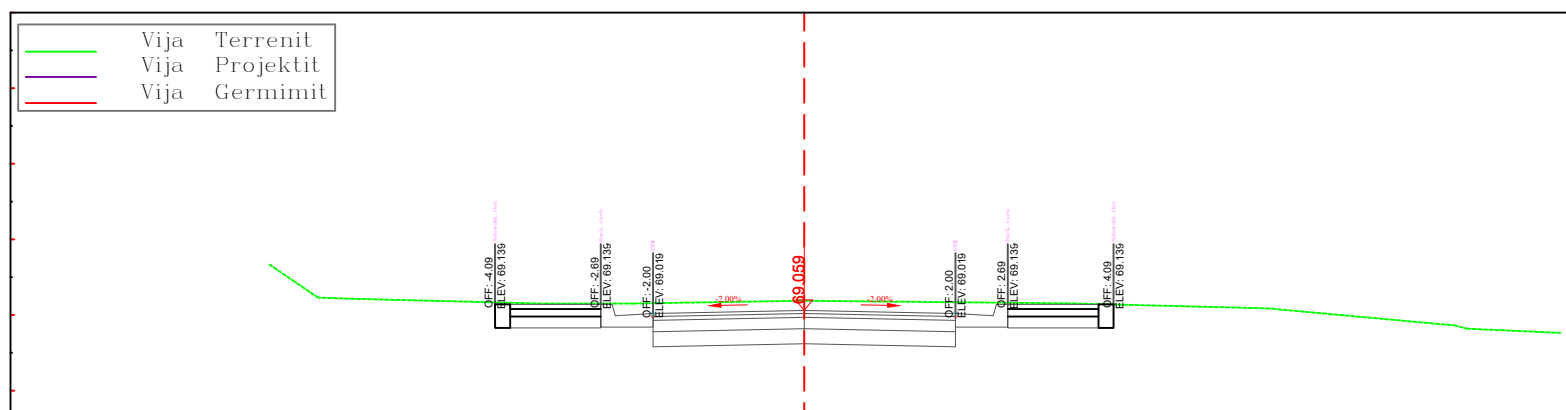

Kuota Terenit	-7.08	-69.67	-69.67	-69.67	-3.42	-69.15	-69.15	-69.15	-0.00	-69.19	-69.19	-69.19	3.49	-69.15	-69.15	-69.15	6.13	-69.09	-69.09	-69.09	8.97	-68.82	-68.82	-68.82	-10.00	-68.76	-68.76	-68.76
Kuota Projektit	-6.43	-69.23	-69.23	-69.23	-2.26	-69.15	-69.15	-69.15	-0.00	-69.19	-69.19	-69.19	3.49	-69.15	-69.15	-69.15	6.13	-69.09	-69.09	-69.09	8.97	-68.82	-68.82	-68.82	-10.00	-68.76	-68.76	-68.76
Kuota Projektit	-7.08	-69.67	-69.67	-69.67	-3.42	-69.15	-69.15	-69.15	-0.00	-69.19	-69.19	-69.19	3.49	-69.15	-69.15	-69.15	6.13	-69.09	-69.09	-69.09	8.97	-68.82	-68.82	-68.82	-10.00	-68.76	-68.76	-68.76
Dist.Progresive	-7.08	-69.67	-69.67	-69.22	-3.42	-69.15	-69.15	-69.15	-0.00	-69.19	-69.19	-69.19	3.49	-69.15	-69.15	-69.15	6.13	-69.09	-69.09	-69.09	8.97	-68.82	-68.82	-68.82	-10.00	-68.76	-68.76	-68.76



REPUBLIKA E SHQIPERISE
BASHKIA PATOS

DREJTORIA E HARTIMIT TE PROJEKTEVE, MONITORIMIT TE
INVESTIMEVE DHE TE SHERBIMEVE

OBJEKTI:

**RIKUALIFIKIMI URBAN, BLOKU
LAGJIA "NAFTETARI", PRANE
SHKOLLES "MUHAMET SHEHU"**

Emertimi i Fletes:
PROFILAT THERTHORE
Aksi 5

Grupi i Projektimit:

Ark. Emiljano Gjoni

Ing. Silvana Mici

Ing. Ueda Isufaj

DREJTORIA E HARTIMIT TE
PROJEKTEVE, MONITORIMIT TE
INVESTIMEVE DHE TE SHERBIMEVE

Ing. Arben Manoku

SHKALLA

1:100

Fleta:
T-23

SHTATOR
2022

PT
00+040.00

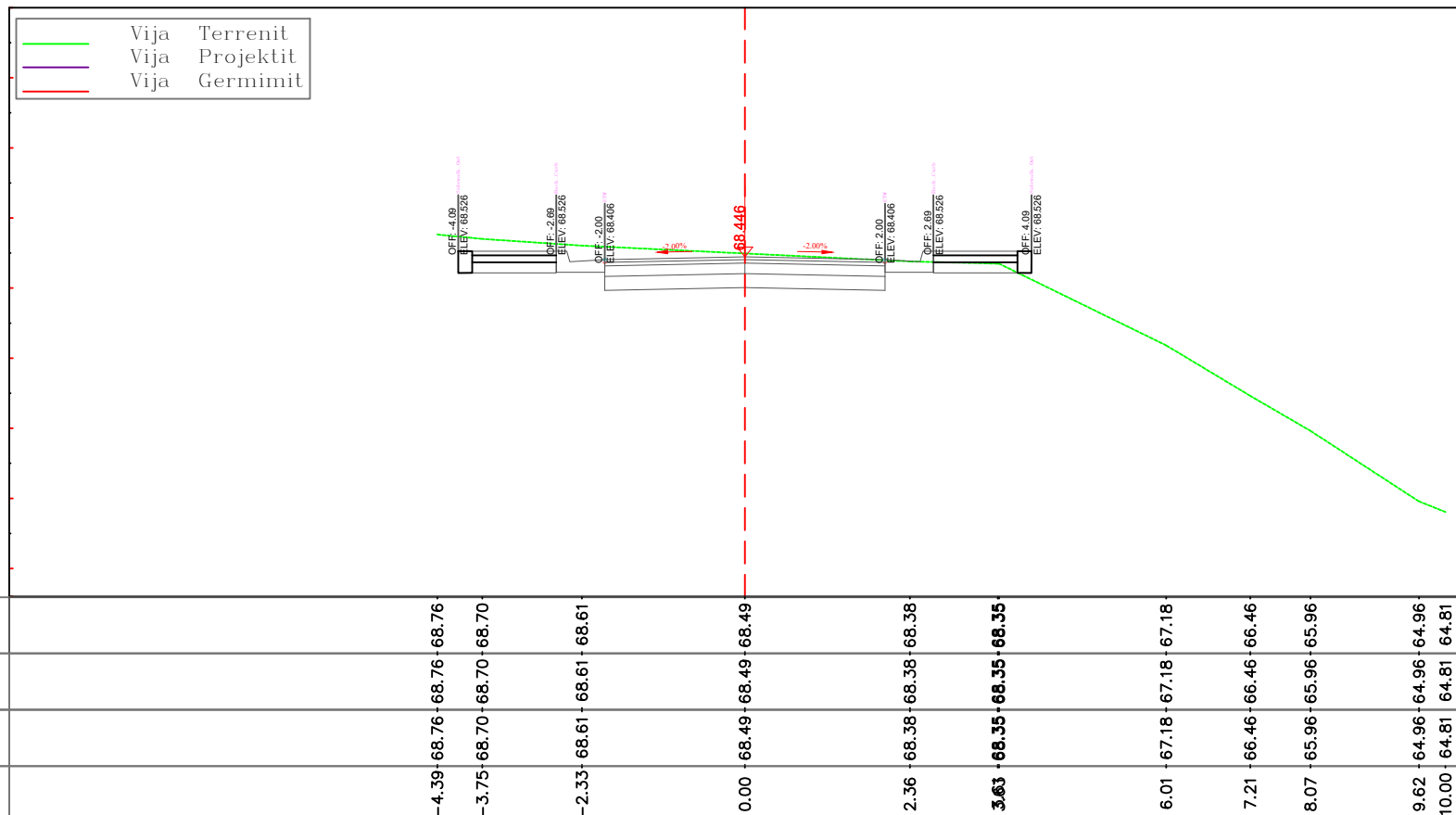

PT
00+050.00

